



# Multi-Core Porosimeter Resistance

## RCT-10K-A



*Not just Products.... Solutions !*

# DESCRIPTION

A rock sample is held in the sample chamber and compressive stress is applied. While the sample is under compressive stress, the desired properties are measured. The PMI Automated Porosimeter System has been specially designed for testing core samples. Core samples are held in a sleeve which (pneumatic or hydraulic) compresses the sample. The instrument measures the loss of a known amount of gas to computer porosity. The equipment is fully automated. Execution of the test, data acquisition, data storage, & data management are all carried out by PMI Software. Operator involvement is minimal, and the instrument is robust and requires a minimal amount of care.

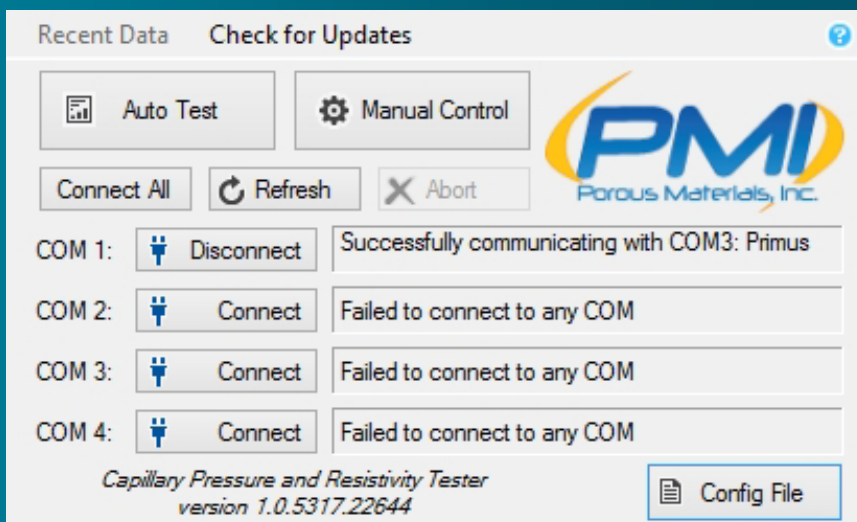
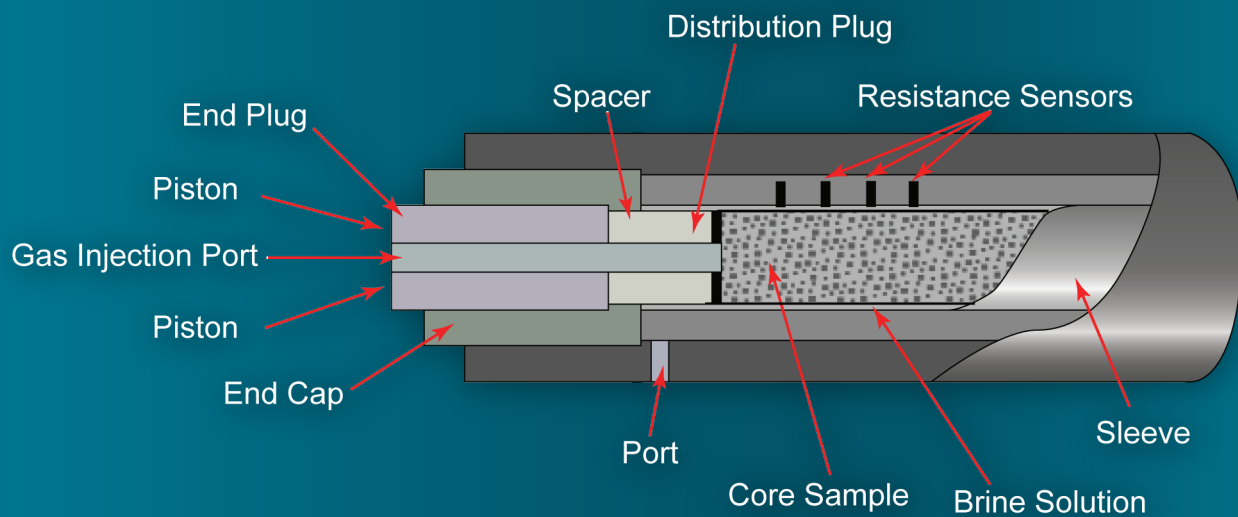

Figure: Title Screen

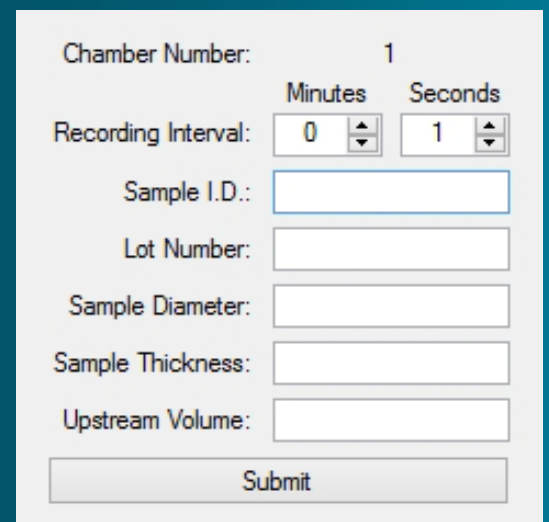

Figure: Test Parameters

# PRINCIPLE

The Porosimeter is used to measure porosity. A known amount of gas is allowed to expand in the sample chamber. Using the Ideal Gas Law, the porosity is computed from the loss in pressure.

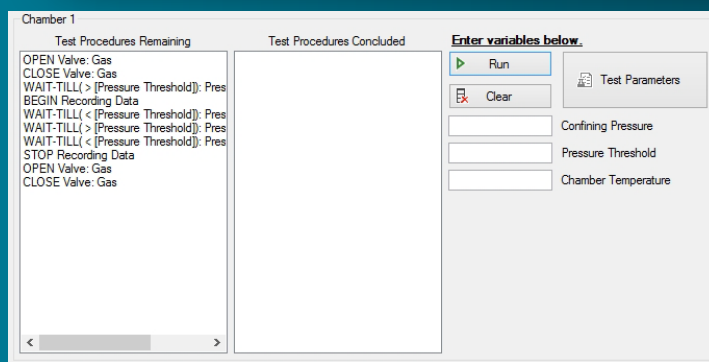
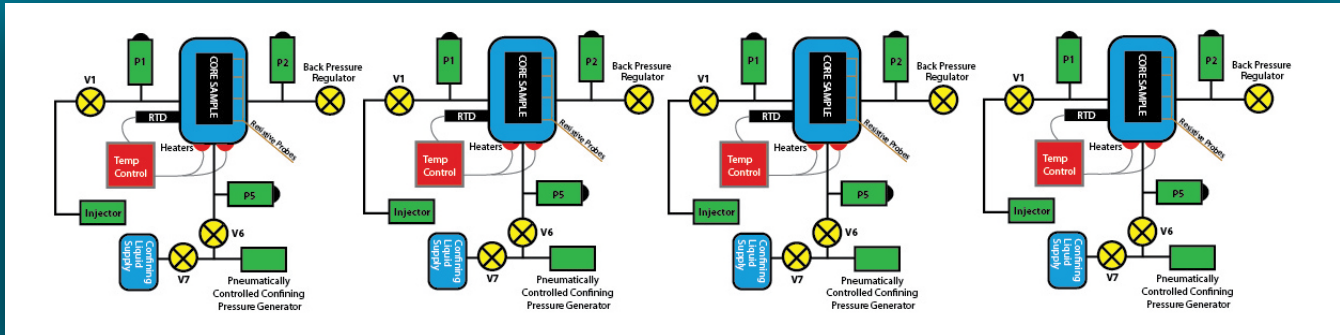

Figure: AutoTest Loaded

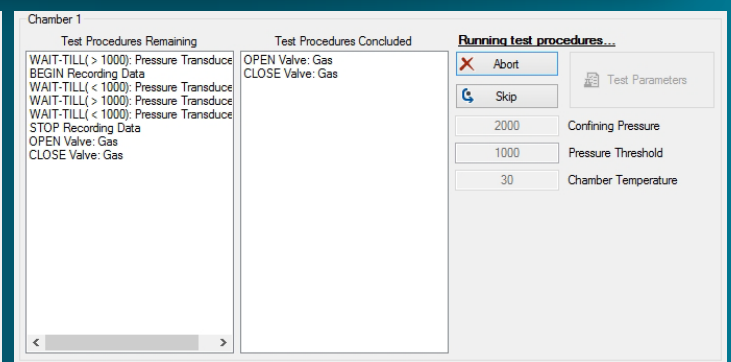

Figure: AutoTest Running

# SYSTEM FEATURES

- The system consists of a bank of Hassler-type 4 electrode core holders mounted on a support frame; each core holder has a dedicated piston cylinder for oil injection, a pressure transducer, and a double glass pipette to collect the eluded brine (as a visual cross check on the computer monitored injection volumes).
- A stepper motor drives each bank of five piston cylinders capable of controlling injection rates of 0.04 cm<sup>3</sup>/ hour or less.
- Each core holder/cylinder pair has an independent valve manifold, with manual valves and a regulator to apply backpressure when saturating the core.
- Resistivity is measured sequentially at regular programmable intervals by a programmable RCL meter linked to the PC based data acquisition software.
- Confining pressure is applied to the core holders by an air driven hydraulic pump module.
- The system is contained in a temperature controlled environmental cabinet. The PC based data acquisition software logs resistance, phase angle, pump displacement, pressure and temperature as well as pump control.
- Heating System- coiled jacket up to 170 degrees C
- Four Core Holder at reservoir Temp (150 degrees C) and pressure
- All valves are automated

# DATA ACQUISITION

A PC is required for data display and acquisition, display and analysis. Interface between software for analysis, data equipment and PC acquisition, and experiment control is included with the unit Serial communications port includes connection to optional printer and computer. Output uses excel compatible spreadsheet calculations for data analysis.

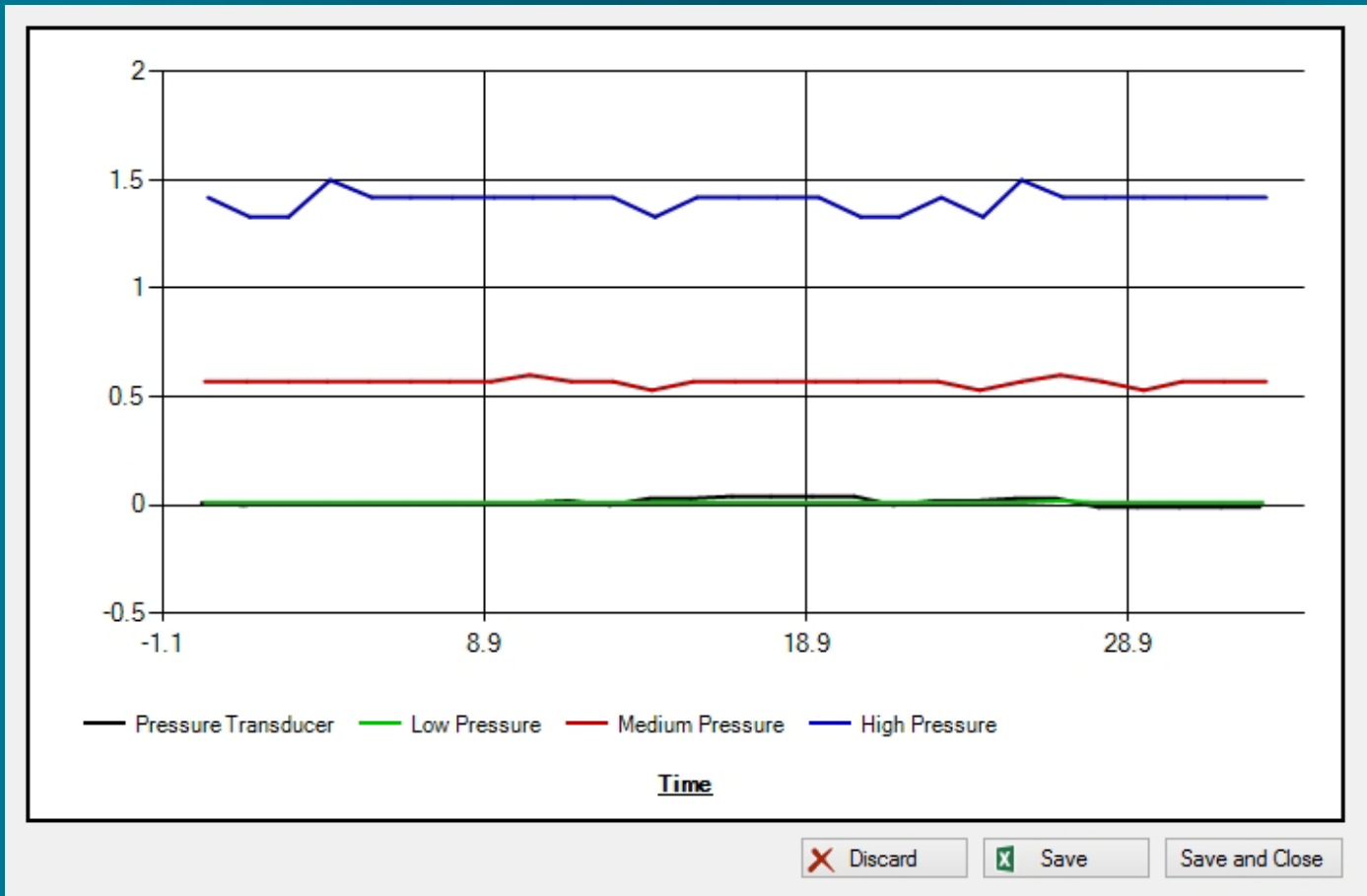

Figure: AT Chart

## SOFTWARE FEATURES

- Capable to be programmed for automatic repeat measurements or for data acquisition under user selected tolerances.
- Graphic presentation of the data to be evaluated and analysis results
- Exporting graphic files to window based word / excel processing files for report generation
- Provision for off-line data processing.
- Integrated detailed help system

# SPECIFICATIONS

- **Core Diameter:** 1.5"
- **Core length:** up to 7 cm
- **Pore Pressure:** 1500PSI
- **Confining Pressure:** 10,000 psi<sup>2</sup>
- Oil Wet disc and Water wet disc
- **Gas used:** Helium or N
- **Voltage:** 220/240 V -50Hz

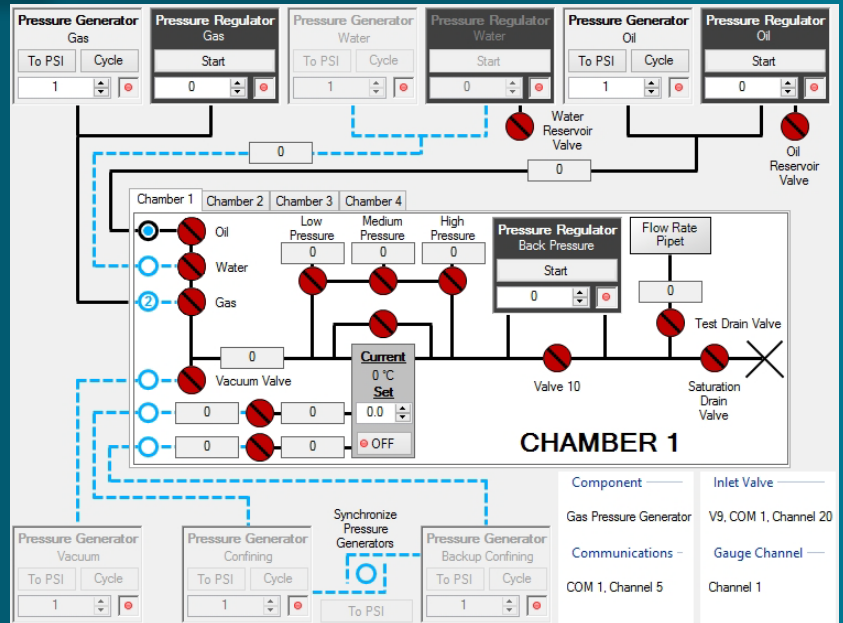

Figure: AT Chart

# SPARE PARTS

- 4) 1.5 inch replacement sleeves
- (5) Seal Kits for Pressure Pumps
- (4) Replacement Automated Valves
- (15) Ceramic Discs
- (15) Semi-permeable Discs
- 15) Oil Wet Discs
- (20) Viton Sleeves

# SALES & SERVICE

Our sales team is dedicated to helping our customers find which machine is right for their situation. We also offer custom machines for customers with unique needs. To find out what we can do for you, contact us. We are committed to customer support including specific service products, short response times & customer specific solutions. To quickly & flexibly meet our customer's requirement, we offer a comprehensive range of services.



*The most advanced, accurate, easy to use  
and reproducible porometers in the world*

*Celebrating*



*of solutions*



20 Dutch Mill Rd, Ithaca, NY 14850, USA  
Toll Free (US & Canada): 1-800-TALK-PMI (1-800-825-5764)  
Phone: 607-257-5544 Fax: 607-257-5639

Email: [info@pmiapp.com](mailto:info@pmiapp.com)

[www.pmiapp.com](http://www.pmiapp.com)

